

COMUNE DI CAVALLINO-TREPORTI

PROVINCIA DI VENEZIA

PROGETTO PARTICOLAREGGIATO  
DELLE TIPOLOGIE DEI MANUFATTI  
AMMESSI DAL PIANO DELL'ARENILE



COMUNE DI CAVALLINO-TREPORTI  
PROVINCIA DI VENEZIA

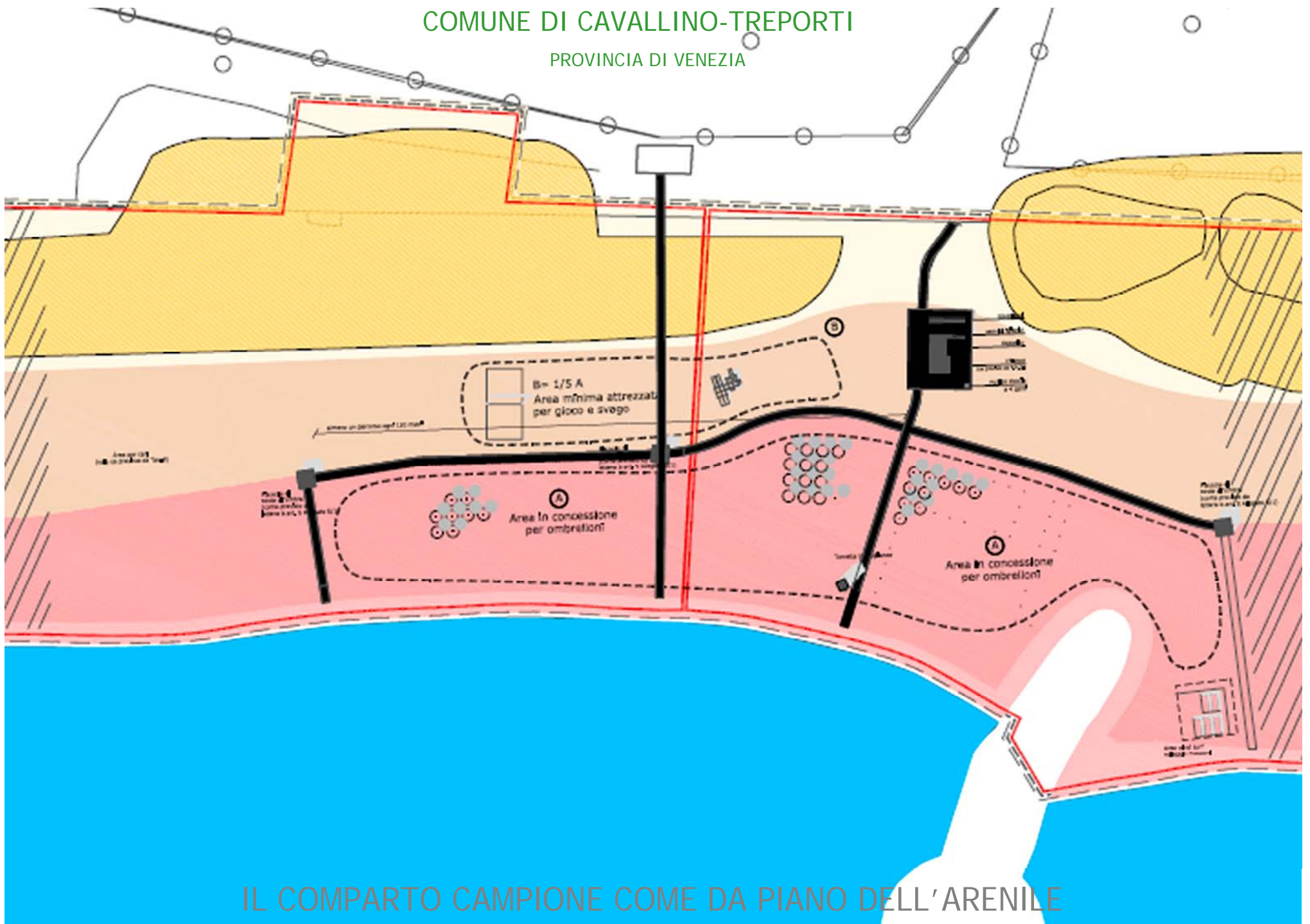

IL COMPARTO CAMPIONE COME DA PIANO DELL'ARENILE



# COMUNE DI CAVALLINO-TREPORTI

PROVINCIA DI VENEZIA



## IL COMPARTO CAMPIONE ED I PERCORSI SU FOTOPIANO

# COMUNE DI CAVALLINO-TREPORTI

PROVINCIA DI VENEZIA

	DUNE		PAVIMENTAZIONE – MAX MQ. 350
	AREA SERVIZI		AREA COPERTA – MAX MQ. 150
	AREA SOGGIORNO		AREA SERVIZI – MAX MQ. 90
	BATTIGIA	①	CHIOSCO
	PERCORSO 01	②	SERVIZI IGIENICI
	PERCORSO 02	③	DOCCIA 4 GETTI
	PERCORSO 03	④	CABINE
	PERCORSO 04	⑤	SOSTA OMBRA
	STABILIMENTO	⑥	TORRETTE
	CHIOSCO – MAX MQ. 35	⑦	"PONTI" IN LEGNO SOPRA LE DUNE COME DA N.T.A.

## LEGENDA AREE, PERCORSI E STRUTTURE TIPO

# COMUNE DI CAVALLINO-TREPORTI

PROVINCIA DI VENEZIA

- 01 - CESTINI
- 02 - POSACENERE
- 03 - DELIMITAZIONI
- 04 - PALI PORTABANDIERA
- 05 - TOTEM INFORMATICI
- 06 - ELEMENTI PER PARTERRE
- 07 - ELEMENTI PER PERCORSI
- 08 - STRUTTURE DI SOSTA ALL'OMBRA
- 09 - CABINE SPOGLIATOIO
- 10 - CABINE SERVIZI IGIENICI
- 11 - TORRETTE DI SALVATAGGIO
- 12 - FIORIERE
- 13 - LAVELLI
- 14 - DOCCE
- 15 - SEGNALETICA DI SERVIZIO
- 16 - SDRAIO
- 17 - OMBRELLONI
- 18 - TENDE PER BAGNANTI

ELENCO DEI MANUFATTI E DELLE STRUTTURE TIPO ESTRAPOLATI DAL PIANO



**CESTINO ROTONDO**

Cestino in acciaio inox o legno dipinto a due colori: azzurro/bianco

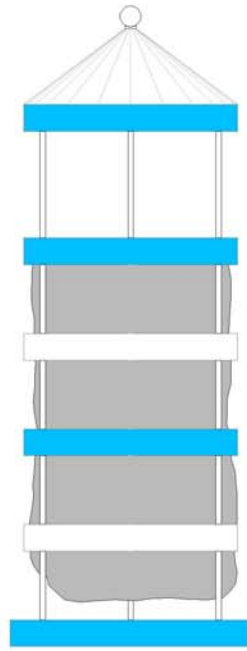
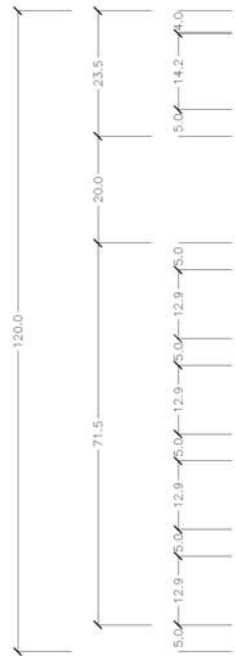

PROSPETTO

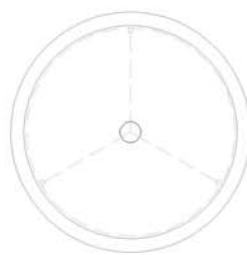
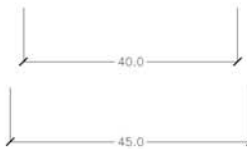

PIANTA

SCALA 1:10

### CESTINO ROTONDO

Cestino in acciaio inox o legno dipinto a due colori: azzurro/bianco

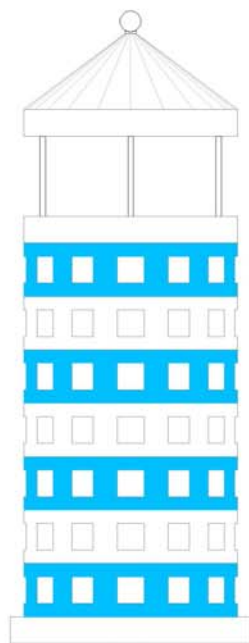
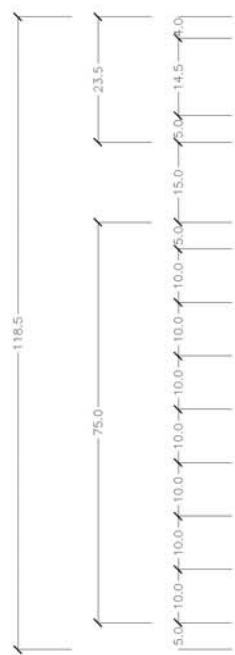

PROSPETTO

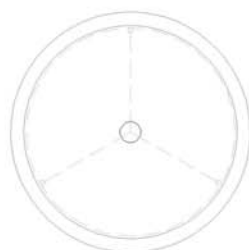
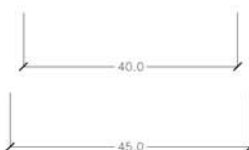

PIANTA

SCALA 1:10

### CESTINO ROTONDO APRIBILE

Cestino in acciaio inox o legno dipinto a due colori azzurro/bianco con coperchio apribile

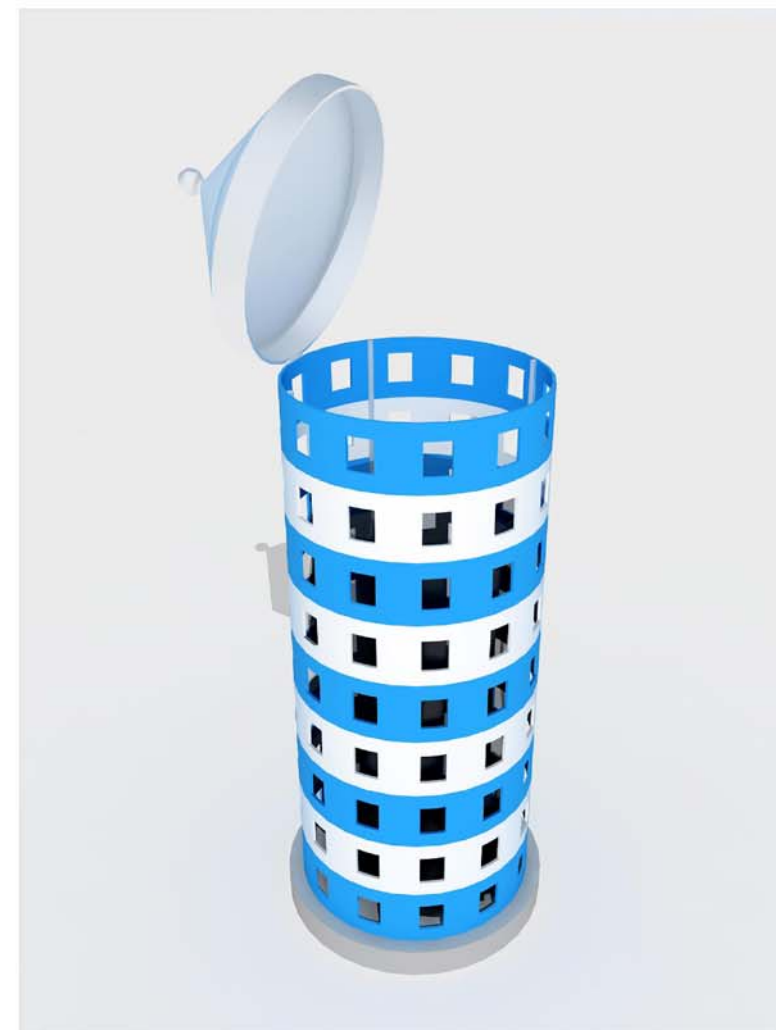
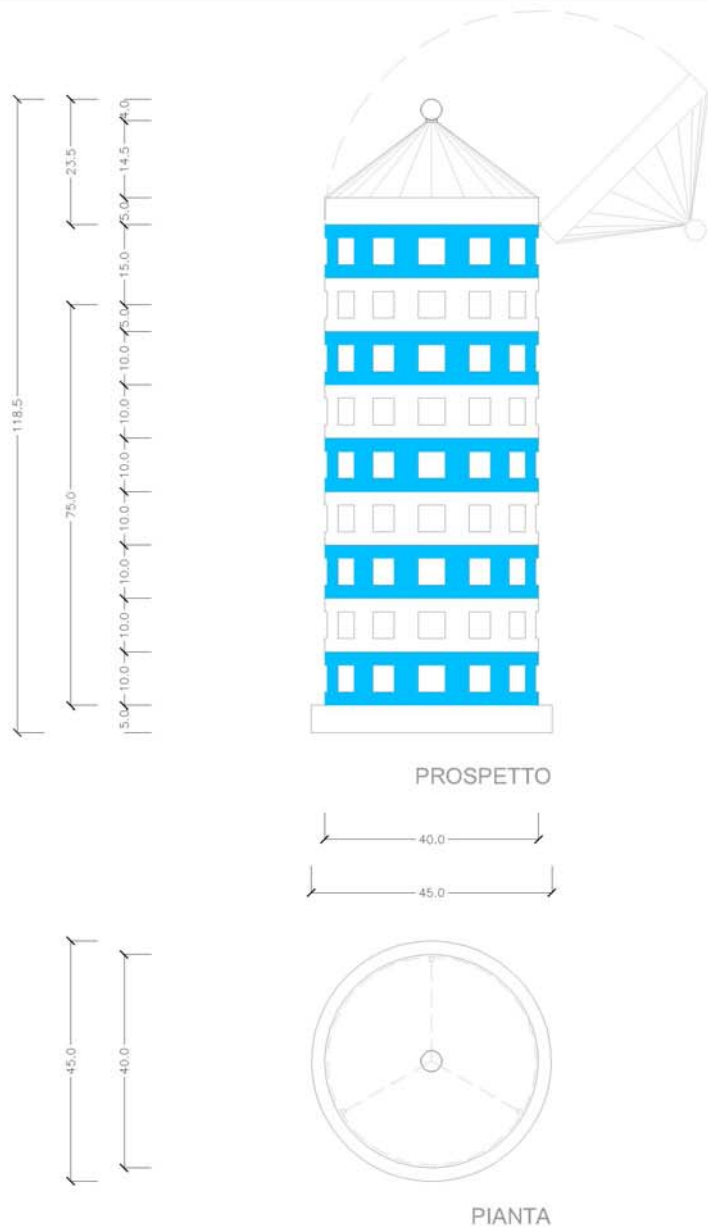

SCALA 1:10



## CESTINO APRIBILE

Cestino in metallo dipinto a due colori azzurro/bianco con coperchio apribile.

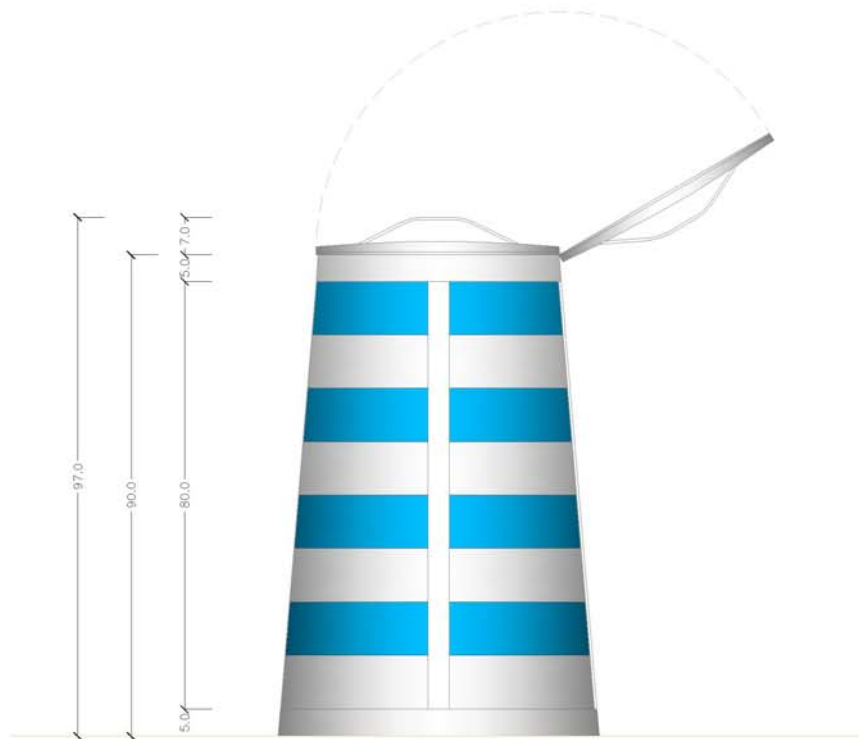

PROSPETTO

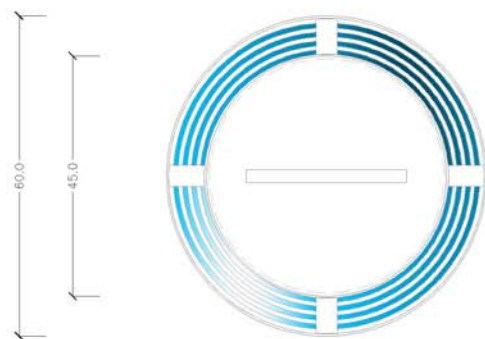

PIANTA

SCALA 1:10

## CESTINI RACCOLTA DIFFERENZIATA

Elementi singoli accostabili per la raccolta differenziata dei rifiuti, struttura in cls ed elementi differenzianti in metallo verniciato e con aperture a sportello.

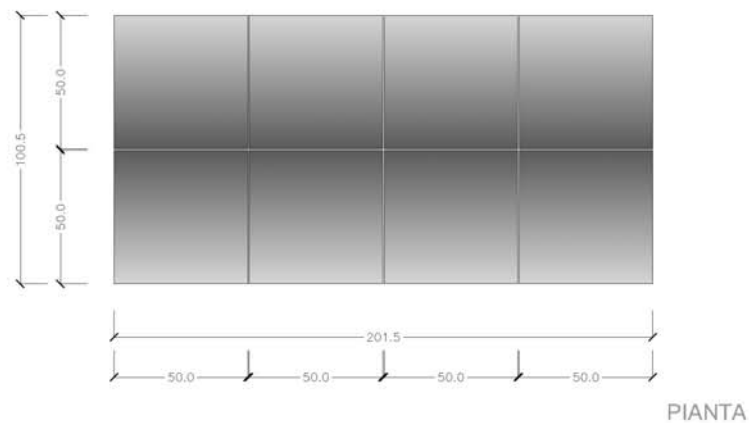
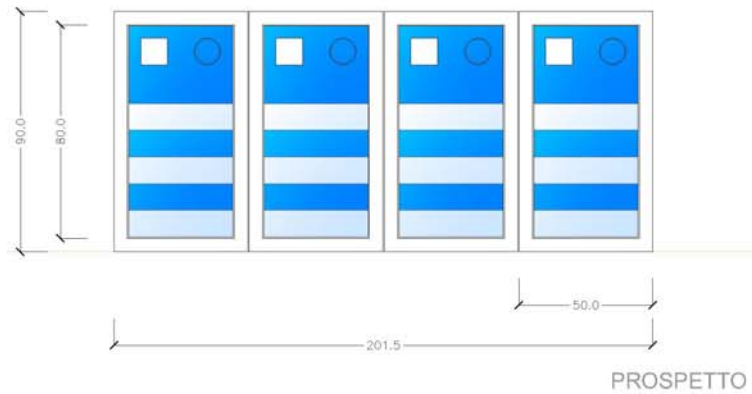

SCALA 1:20

**POSACENERE ROTONDO**

Posacenere in cemento o legno dipinto a due colori: azzurro/bianco riempito di sabbia

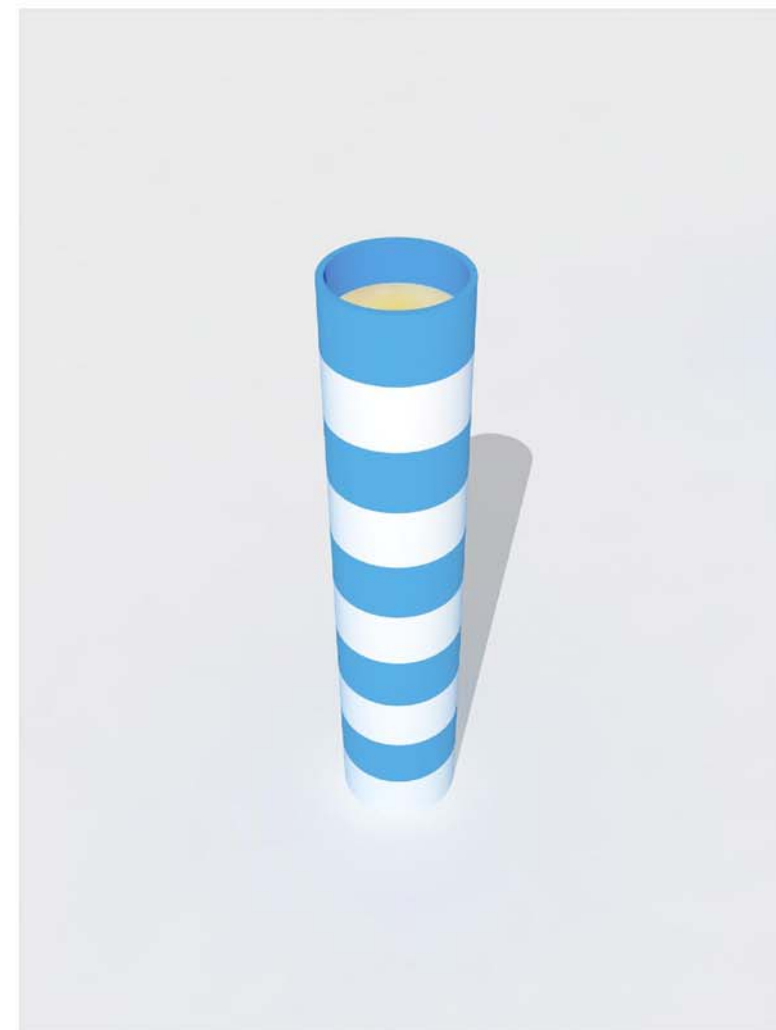
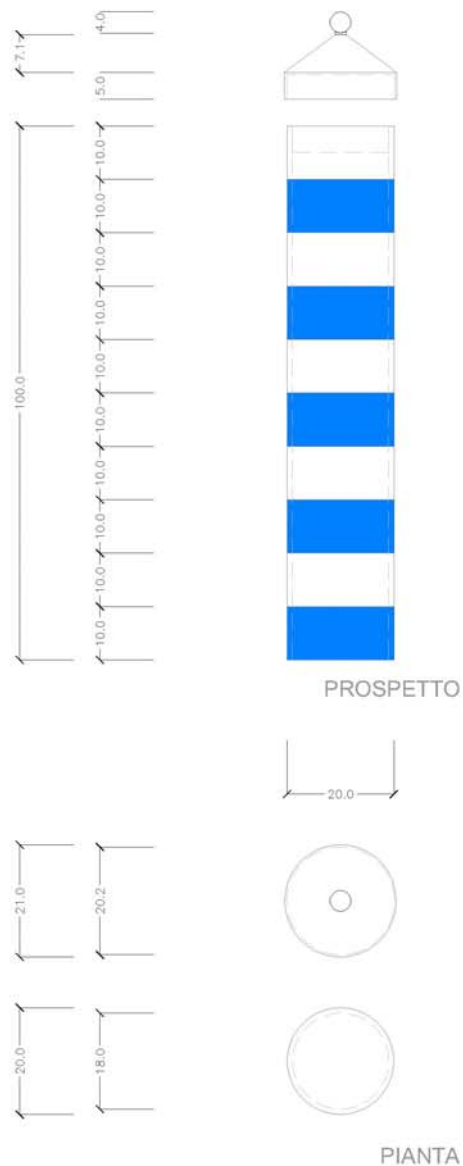

SCALA 1:10

POSACENERE ROTONDO

Posacenere in cemento o legno dipinto ad imitazione di sigaretta riempito di sabbia

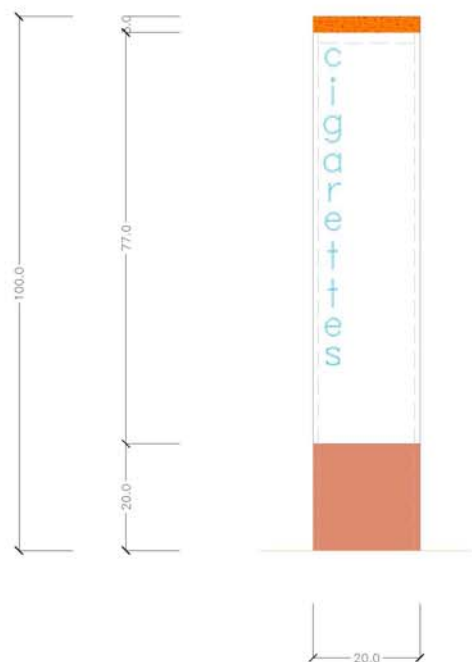

PROSPETTO



PIANTA



SCALA 1:10



ELEMENTI DI DELIMITAZIONE

Paletti in legno o metallo dipinto a due colori:  
azzurro/bianco e corda in fibre naturali

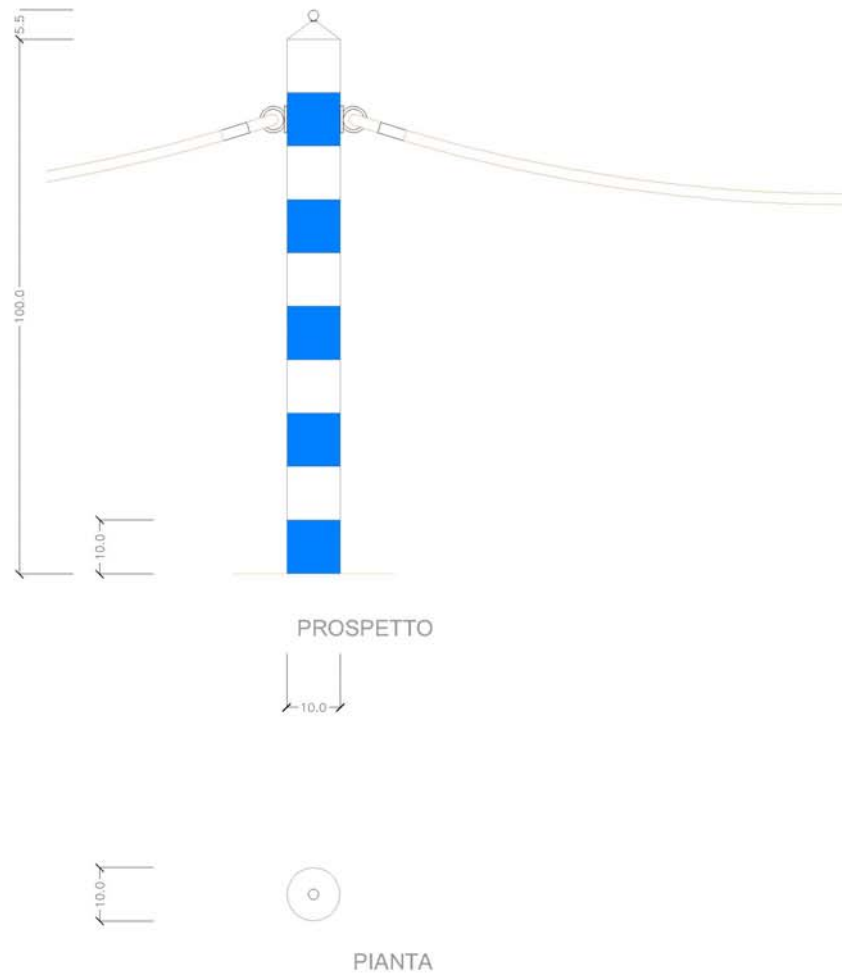

SCALA 1:10

DELIMITAZIONI

Elementi di delimitazione in legno naturale o dipinto.

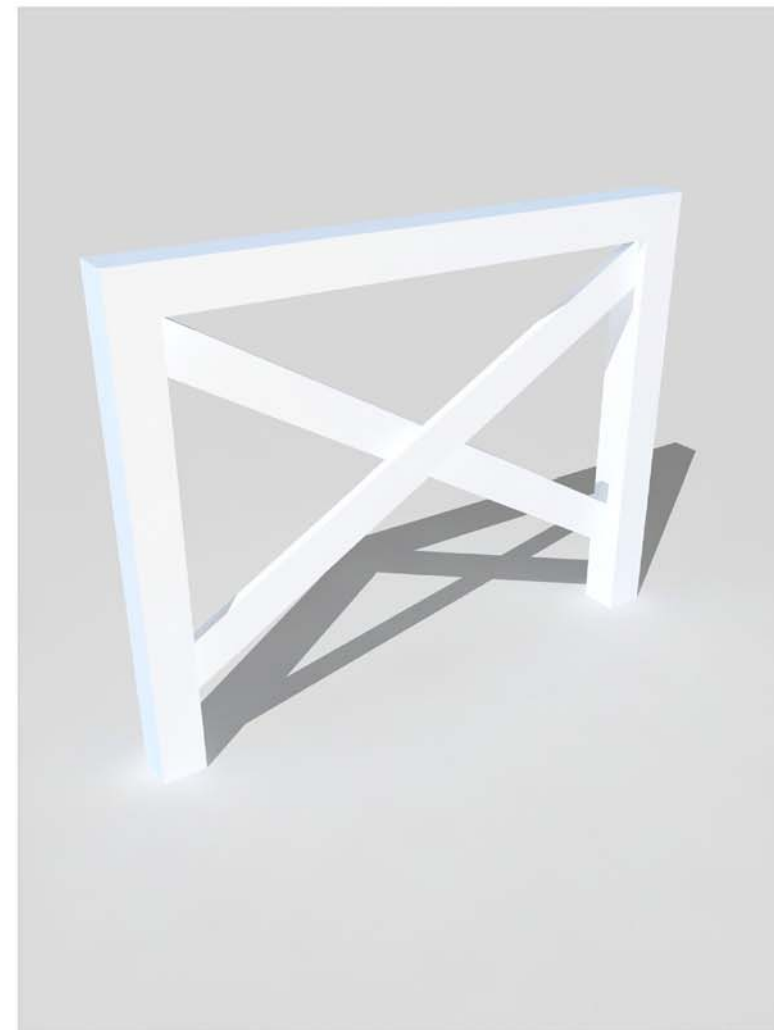
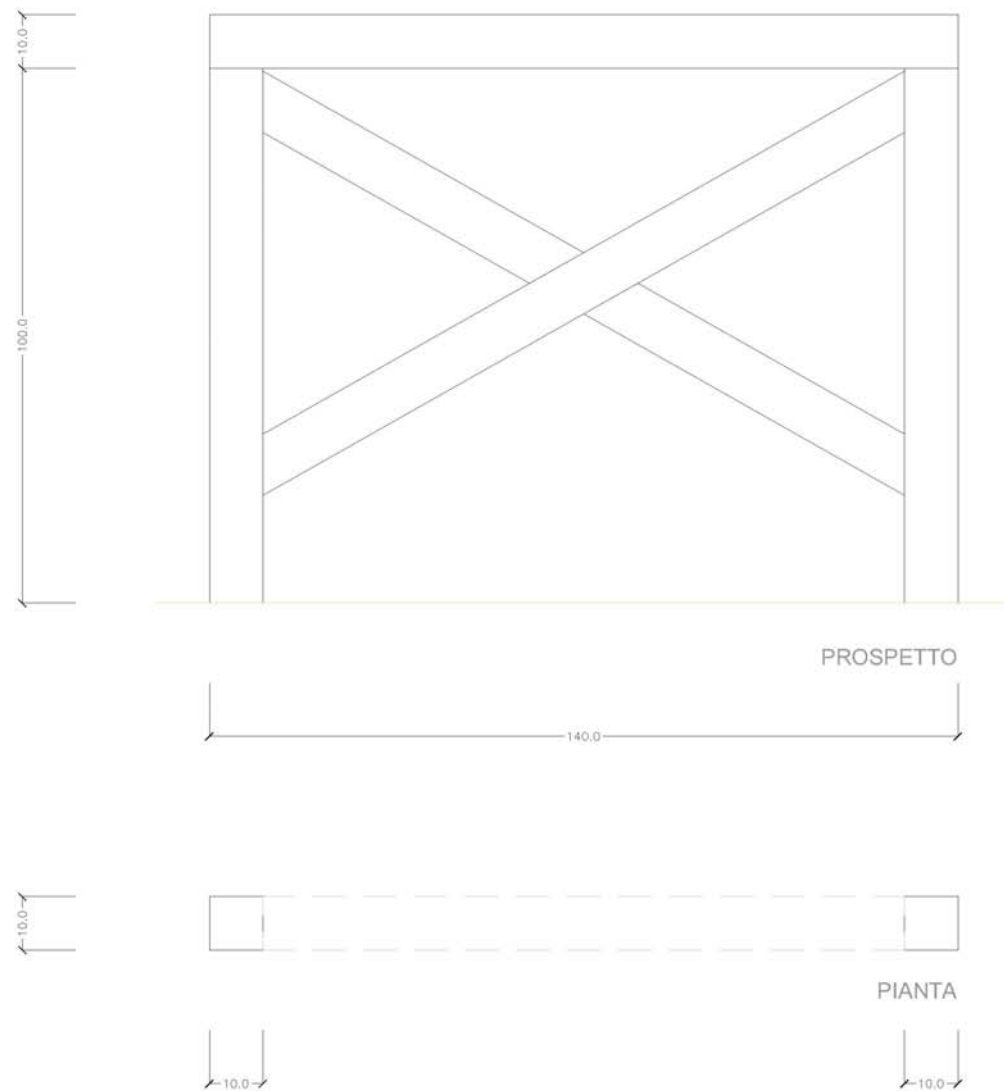

SCALA 1:10

PALO

Palo in acciaio o legno dipinto a due colori:  
azzurro/bianco e corda in fibre naturali

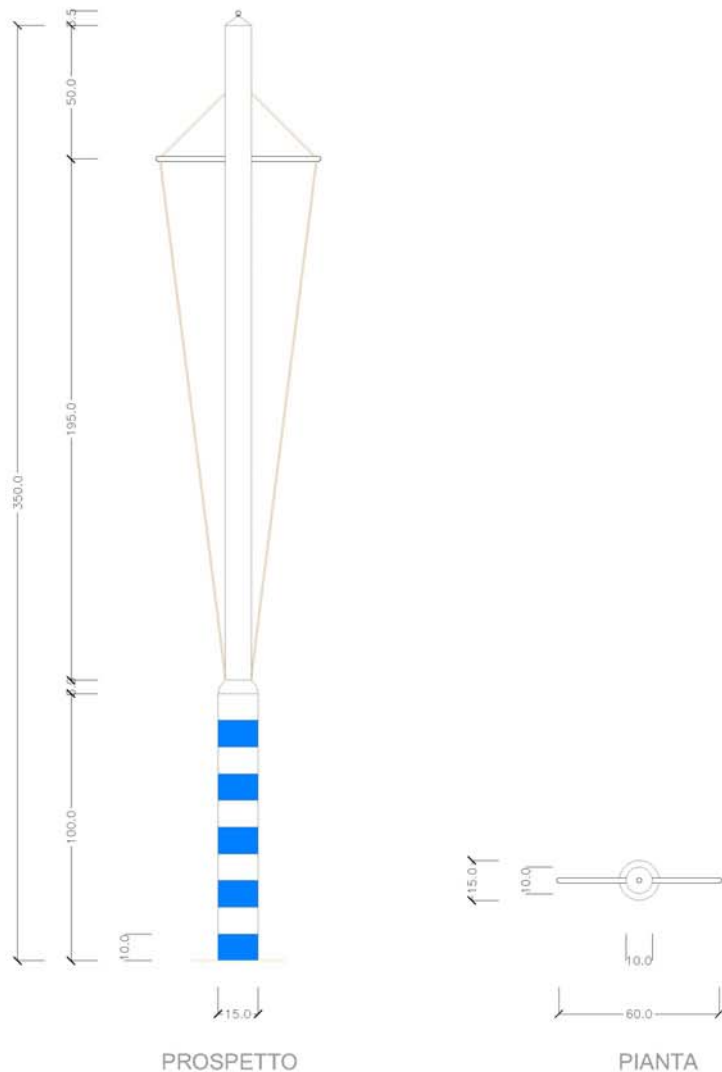

SCALA 1:20

TOTEM INFORMATIVO

Struttura in acciaio o legno dipinto a due colori azzurro/bianco e fondo per affissioni in bianco

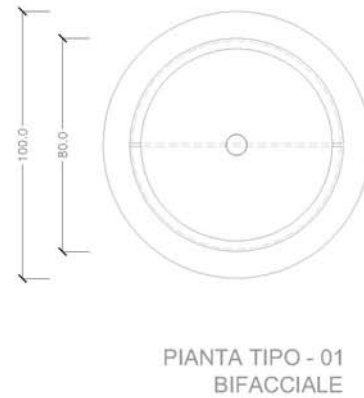
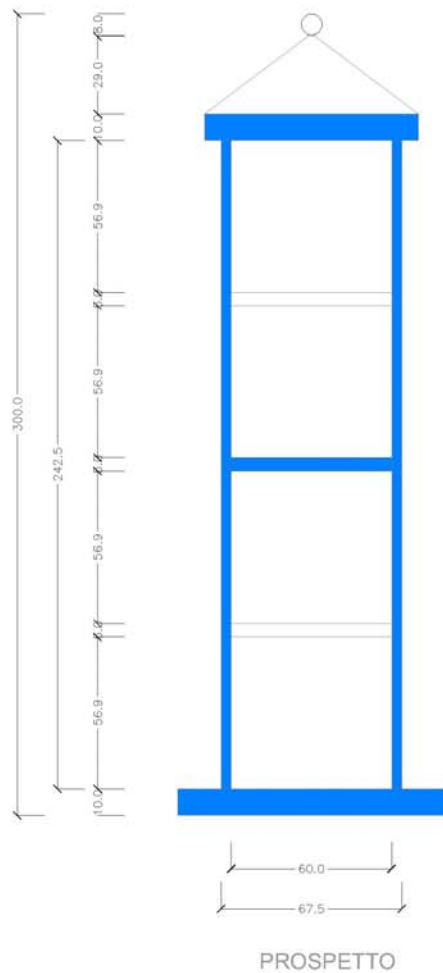

SCALA 1:20



### TOTEM INFORMATIVO

Struttura in acciaio o legno dipinto a due colori azzurro/bianco e fondo per affissioni in bianco

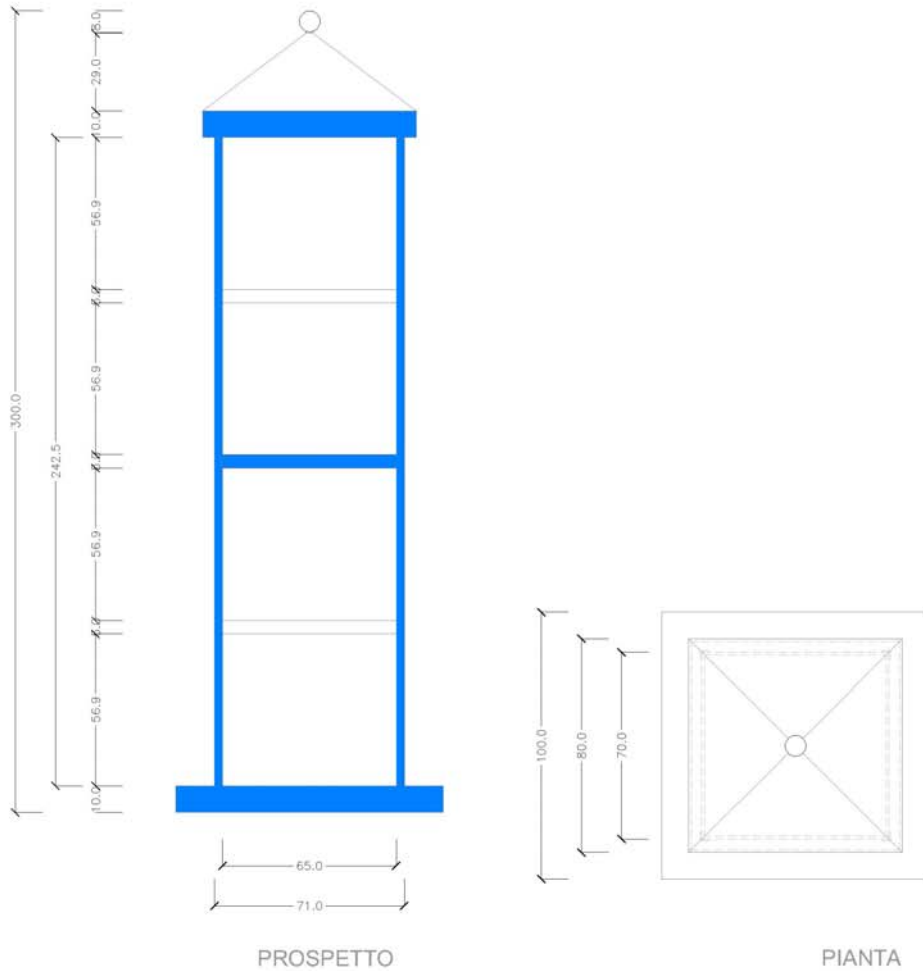

SCALA 1:20

BACHECA INFORMATIVA

Struttura in acciaio o legno dipinto e fondo per affissioni in doghe. Con eventuale scritta soprastante.

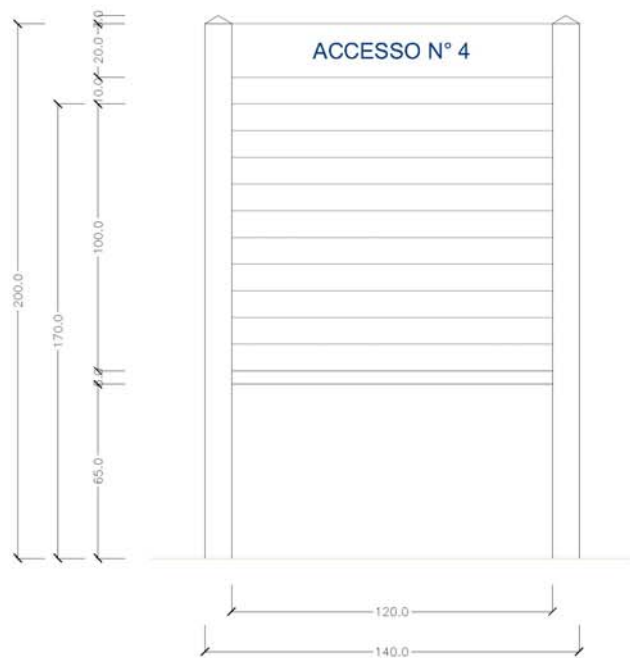

PROSPETTO

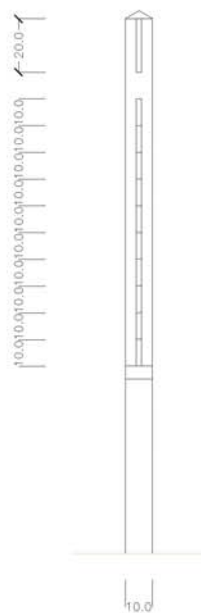

SEZIONE



PIANTA



SCALA 1:20

**BANDIERA BLU**

Struttura in acciaio o legno dipinto e fondo in doghe per affissione bandiera blu. Con eventuale scritta soprastante.

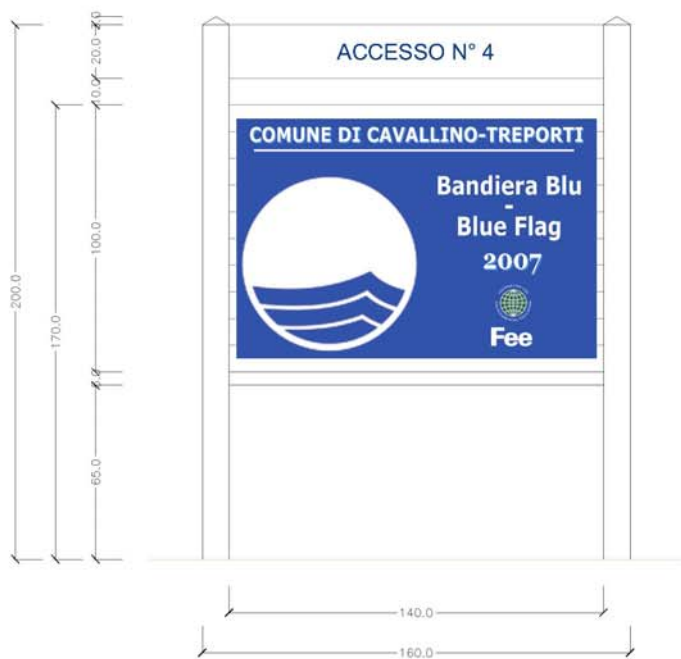

PROSPETTO

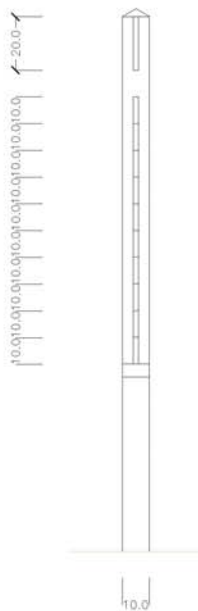

SEZIONE



PIANTA



SCALA 1:20

SOSTA

Elemento composto da parterre (scheda 20) accostati. Struttura in travi ed assi di legno naturale o profili rettangolari in legno e/o materiali compositi legno e resina, eventuale metallo dipinto in posizione d'angolo a sostegno e rinforzo delle strutture in legno e copertura in arelle, delimitazione perimetrale in corda a fibre naturali.

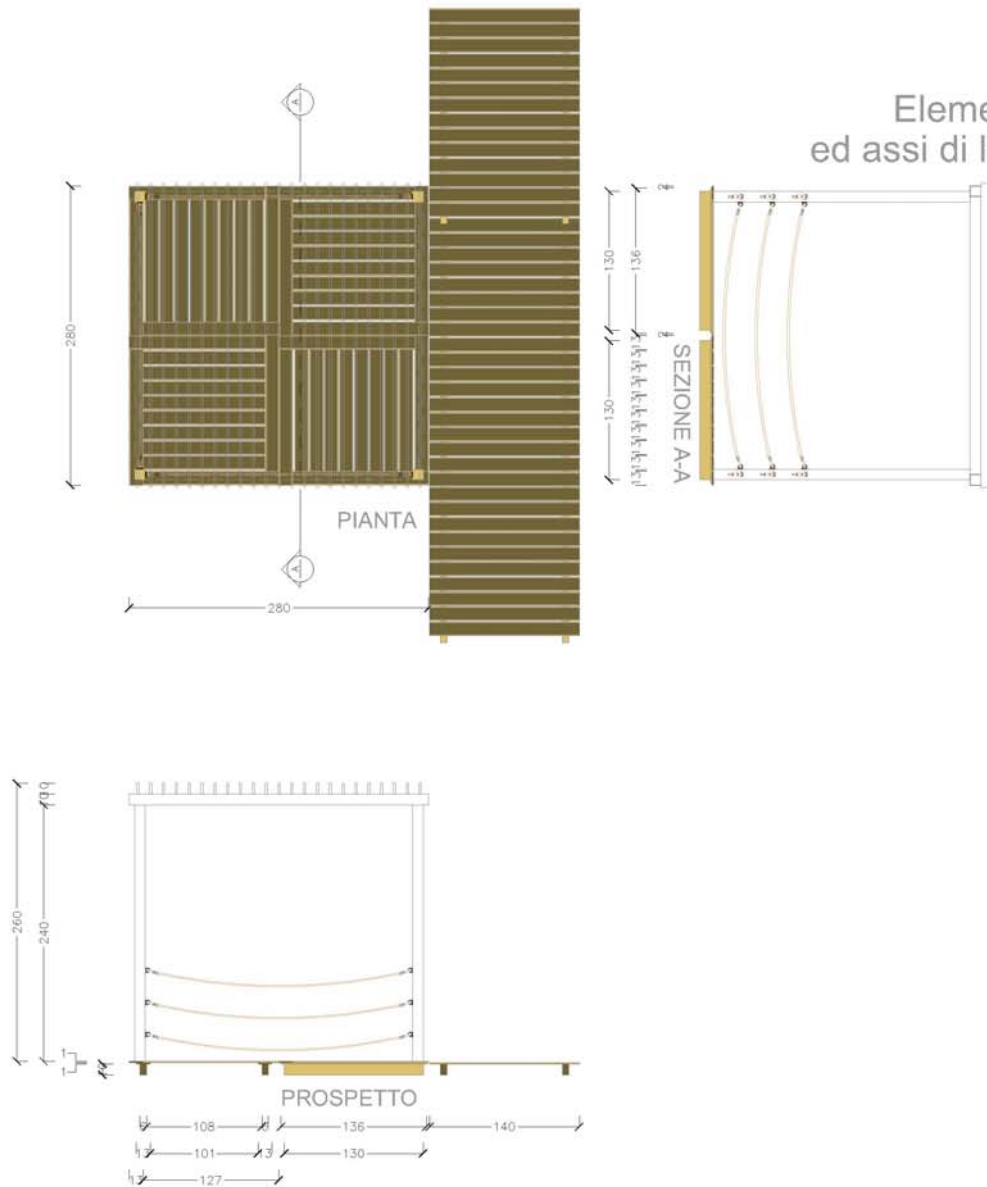

SCALA 1:50



SOSTA

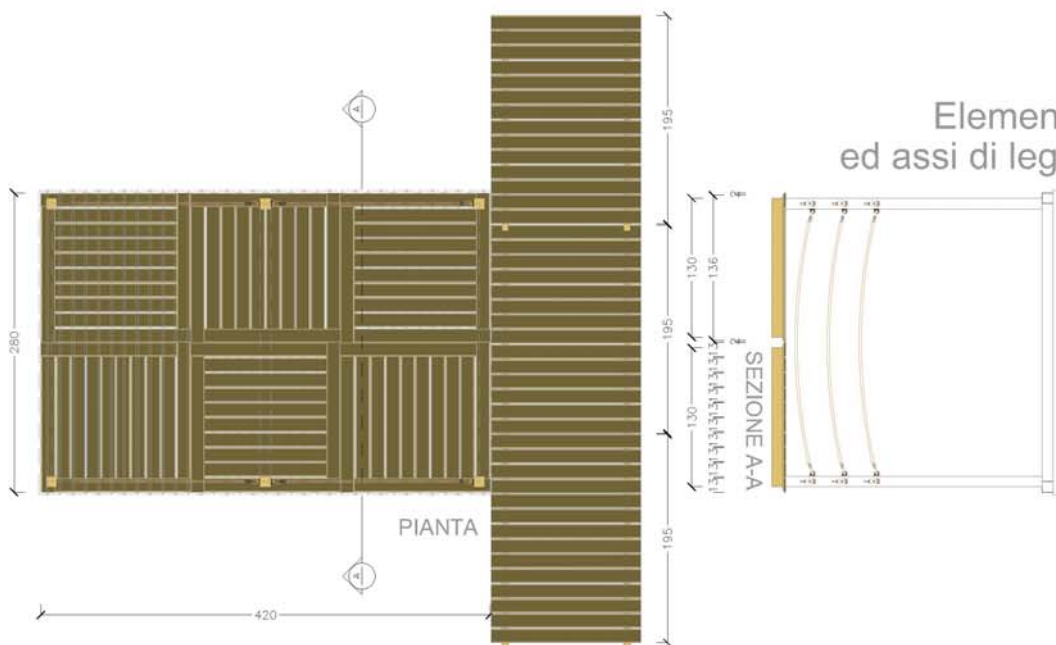

Elemento composto da parterre (scheda 20) accostati. Struttura in travi ed assi di legno naturale o profili rettangolari in legno, e/o materiali compositi legno e resina, eventuale metallo dipinto in posizione d'angolo a sostegno e rinforzo delle strutture in legno e copertura in arelle, delimitazione perimetrale in corda a fibre naturali.

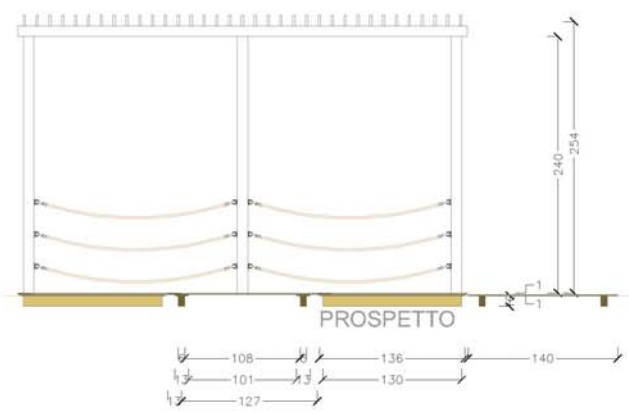

SCALA 1:50

## SERVIZI

Servizi a struttura componibile in legno (naturale o dipinto) e/o materiali compositi in legno e resina, con eventuali elementi in metallo dipinto in posizione d'angolo a sostegno e rinforzo delle strutture in legno, telaio previsto maglia regolare con interasse 110x110 cm. Copertura in legno naturale o dipinto, o vetroresina trattata a "gelcott", bianco. Chiusure verticali con pannelli di legno, o vetroresina coibentata (polistirene o similare).

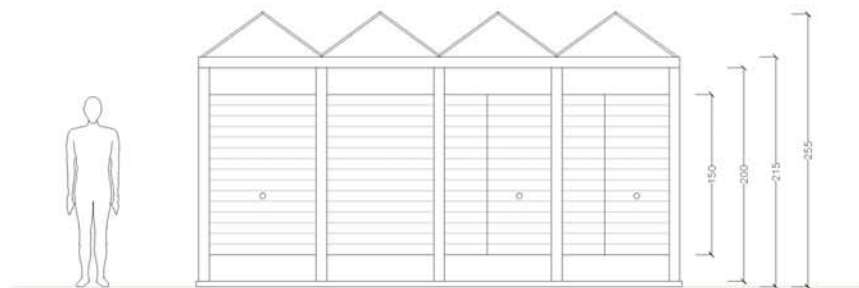

PROSPETTO

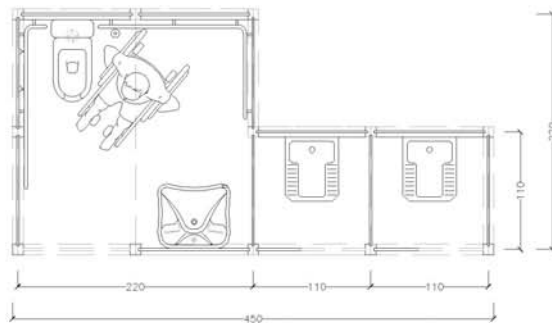

PIANTA



SCALA 1:50

## CABINE

Spogliatoi a struttura componibile in legno (naturale o dipinto) e/o materiali compositi legno e resina, con eventuali elementi in metallo dipinto in posizione d'angolo a sostegno e rinforzo delle strutture in legno, telaio previsto a maglia regolare con interasse di 110x110 cm. Copertura di legno naturale dipinto, o vetroresina trattata a "gelcott", bianco. Chiusure verticali con pannelli in legno, o vetroresina coibentata (polistirene o similare).



PROSPETTO

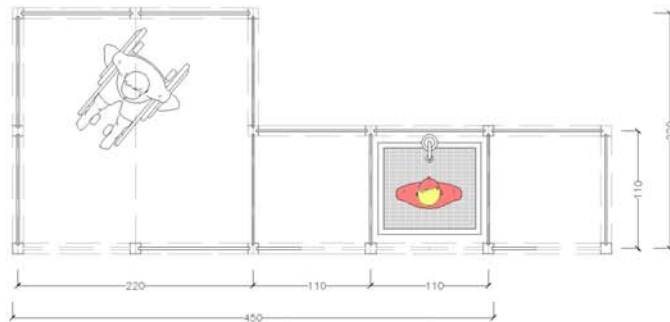

PIANTA

SCALA 1:50



CABINE SU BASE DITTA ARCHISUN

Nucleo attrezzato a wc e spogliatoio su base modello Solaria-Cavallino. Struttura facilmente removibile modulare in legno e/o materiali compositi legno e resina con eventuali elementi in metallo in posizione d'angolo a sostegno e rinforzo delle strutture in legno, vetroresina trattata a "gelcott", pavimenti in alluminio con o senza portico.

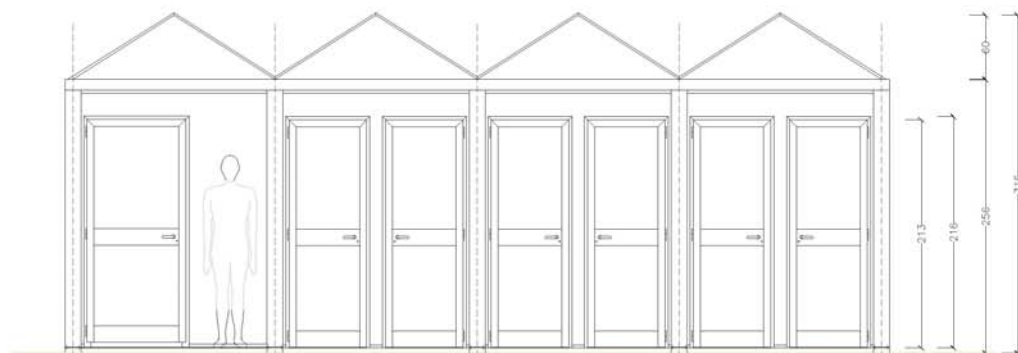

PROSPETTO

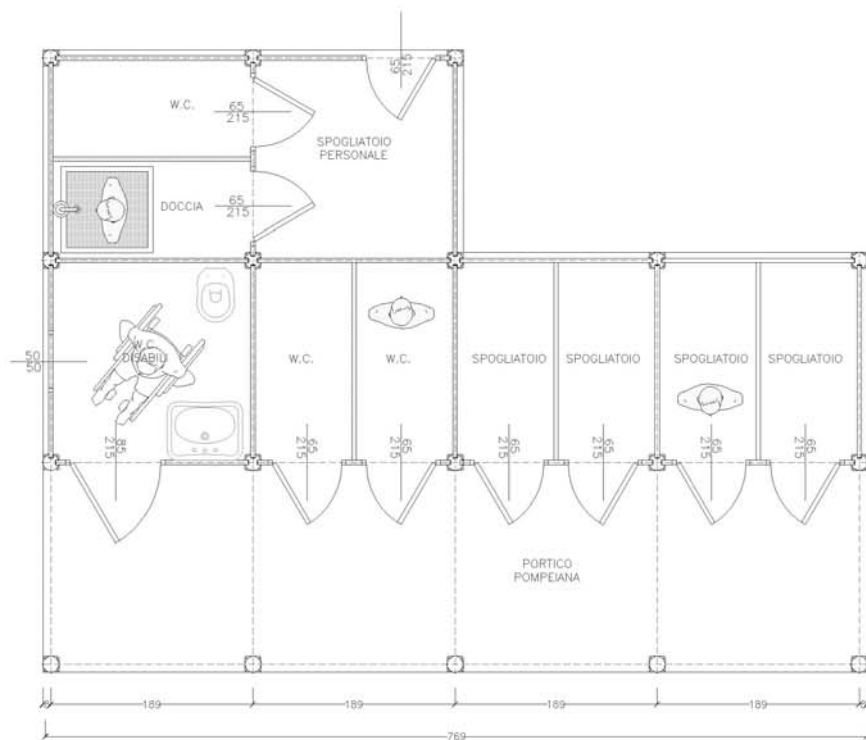

PIANTA

SCALA 1:50

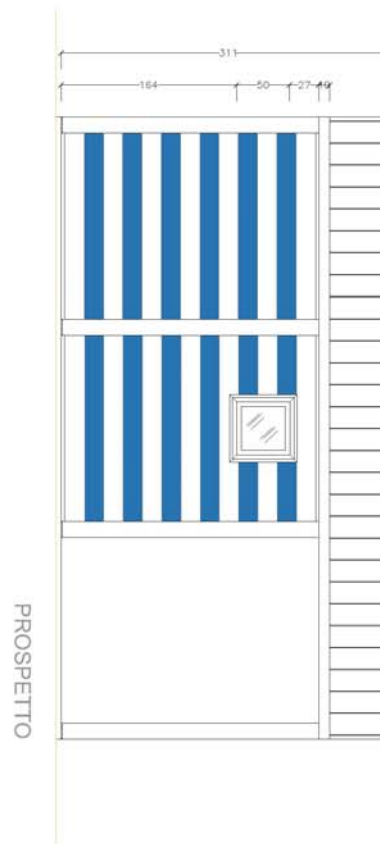

PROSPETTO



TORRETTA FARO CAVALLINO

Torrette servizio di sicurezza con discesa veloce (tipo VVFF).  
Struttura in acciaio e legno dipinto, parapetti in acciaio o corda e telo,  
scala in acciaio, copertura ombreggiante con soleil in metallo.



SCALA 1:50



TORRETTA FARO

Torrette servizio di sicurezza con discesa mediante scala amovibile, struttura in acciaio e legno dipinto, parapetti in acciaio o corda e telo, copertura ombreggiante e deposito materiali nella parte inferiore.



SCALA 1:50

TORRETTA VARIANTE

Torrette servizio di sicurezza con scala amovibile con discesa veloce e vista libero verso il mare. Eventuale deposito materiali nella parte inferiore.

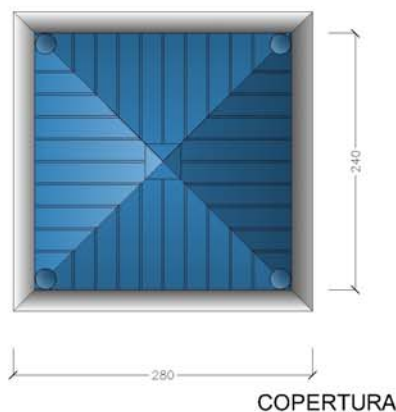
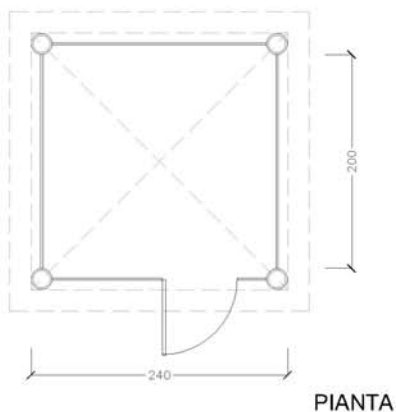
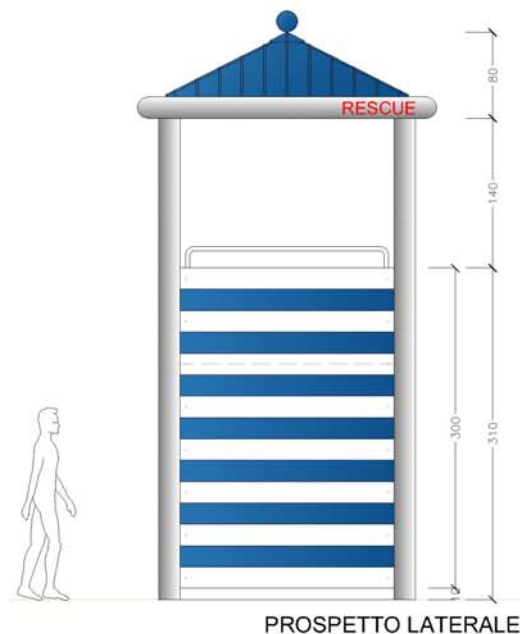
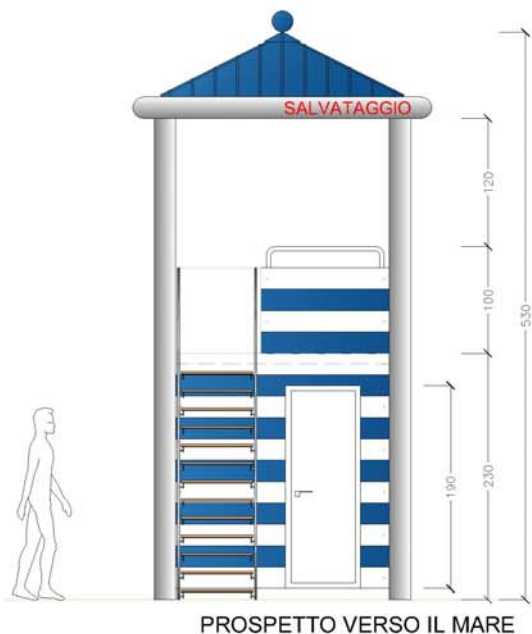

SCALA 1:50

TORRETTA VARIANTE

Torrette servizio di sicurezza con scala amovibile con discesa veloce e vista libera verso il mare  
Eventuale deposito materiali nella parte inferiore.

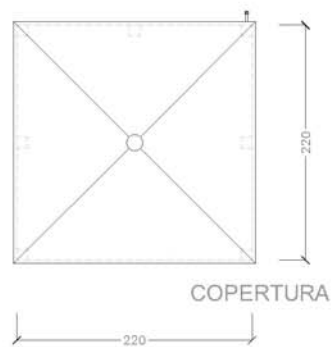
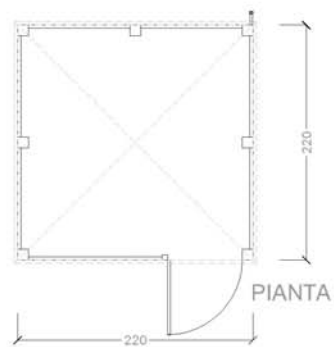
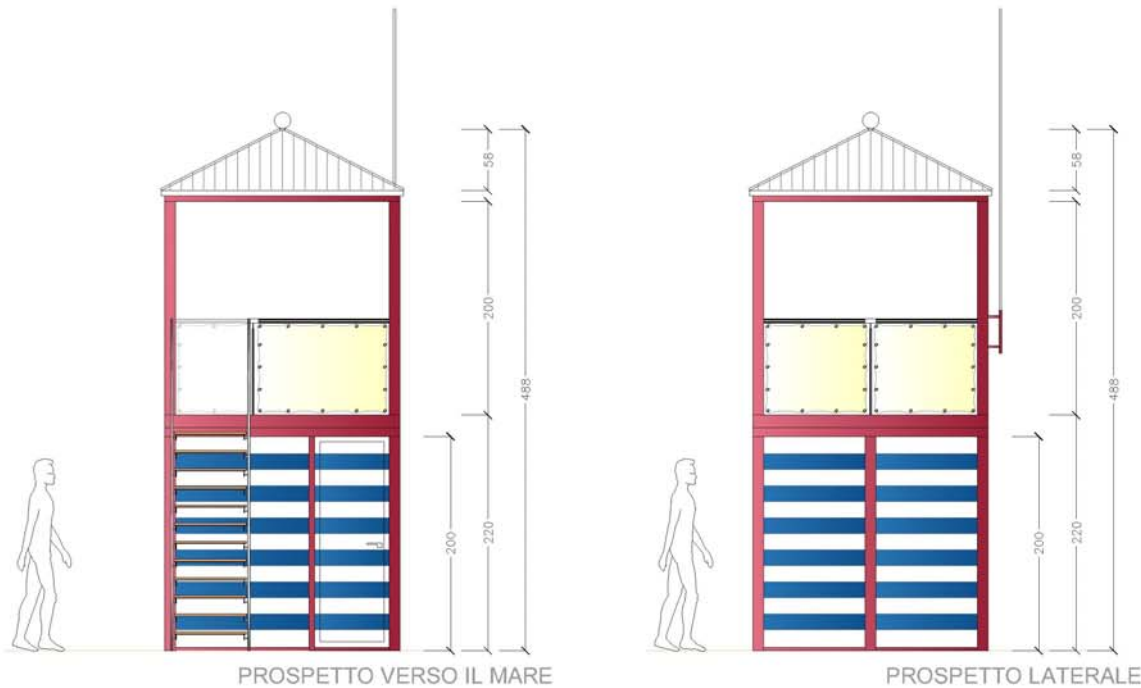

SCALA 1:50

## FIORIERA

Fioriera accostabile in legno naturale o dipinto  
struttura in legno sezione quadrata 5x5 e doghe  
sempre in legno naturale o dipinte.

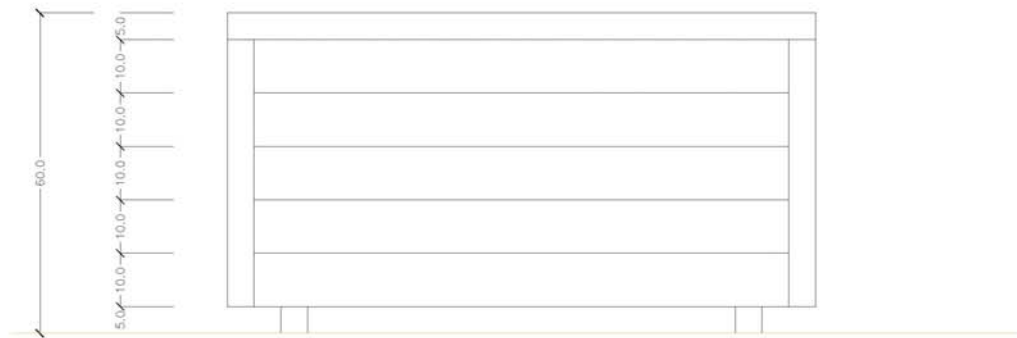

PROSPETTO

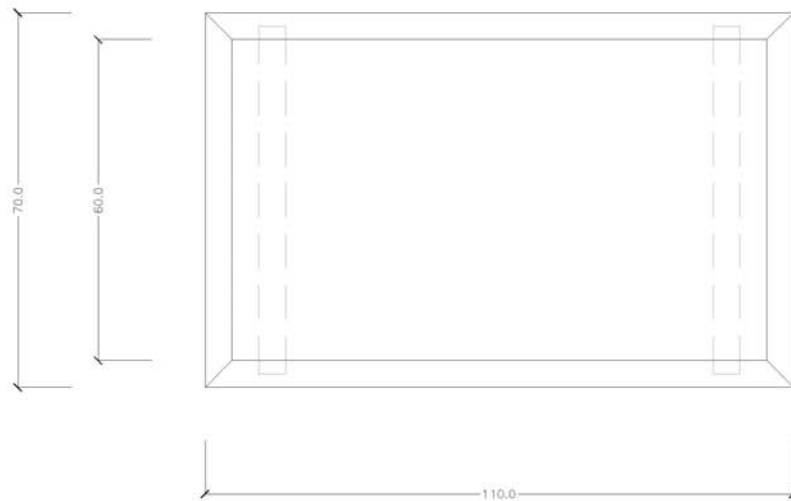

PIANTA



SCALA 1:10

LAVELLO

Lavatoio in acciaio con pulsante a tempo  
struttura in cls armato piastrellato  
divisori in legno naturale o dipinto.

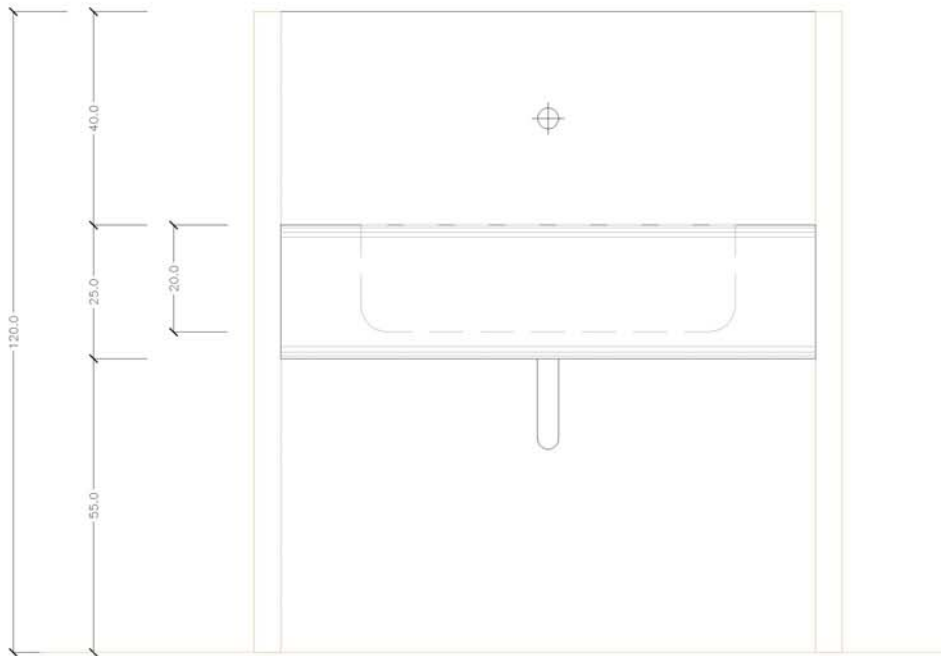

PROSPETTO

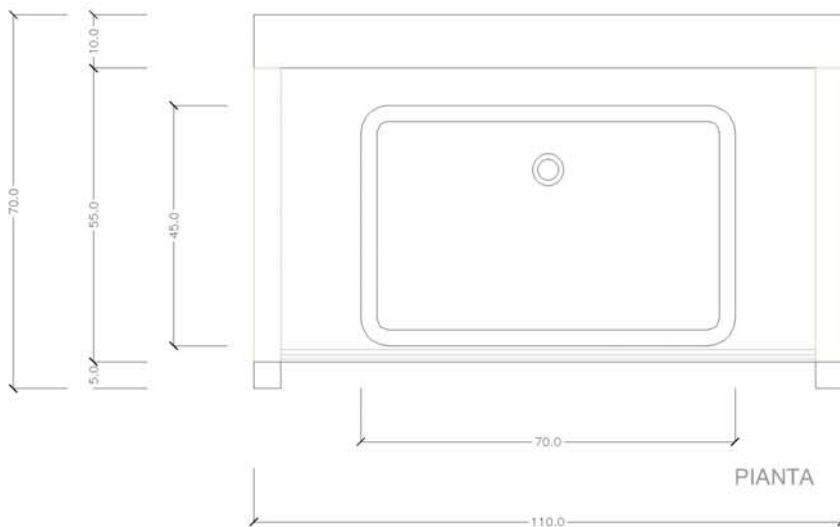

PIANTA

SCALA 1:10





## PUNTO DOCCIA

Punto doccia a quattro soffioni da posizionare in spiaggia con vasca di scolo acque saponate.

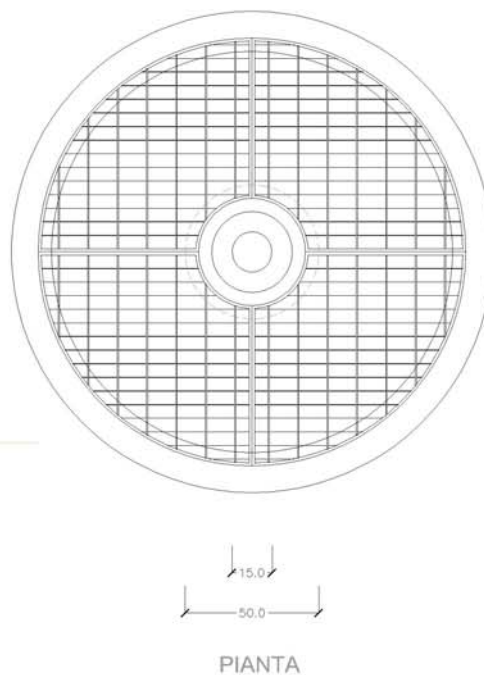
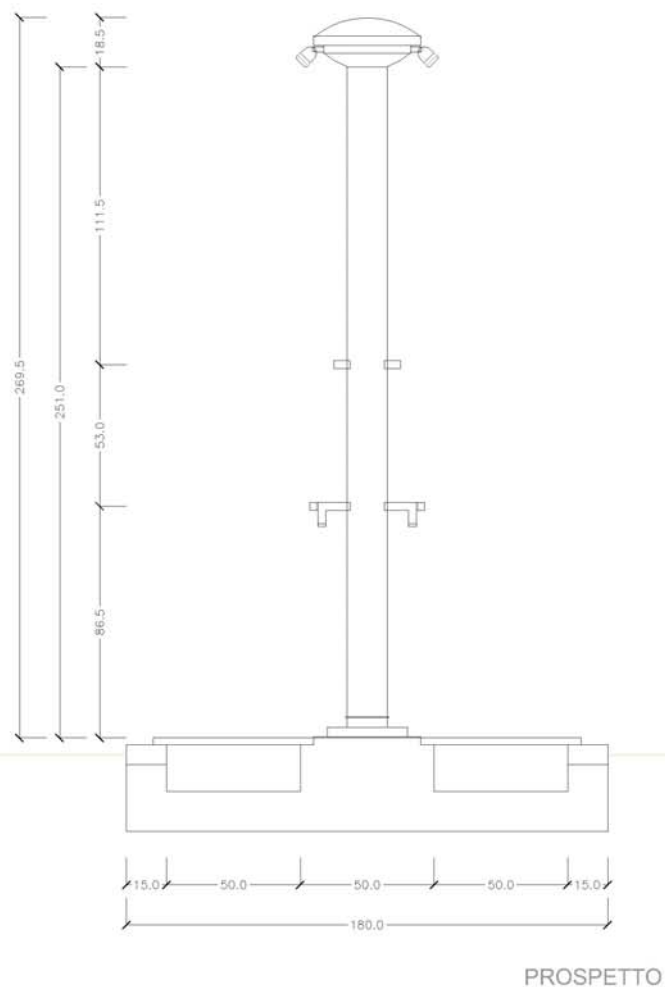

SCALA 1:20

## PUNTO DOCCIA DA SPIAGGIA

Punto doccia a quattro soffioni da posizionare in spiaggia con obbligo di non usare sapone.

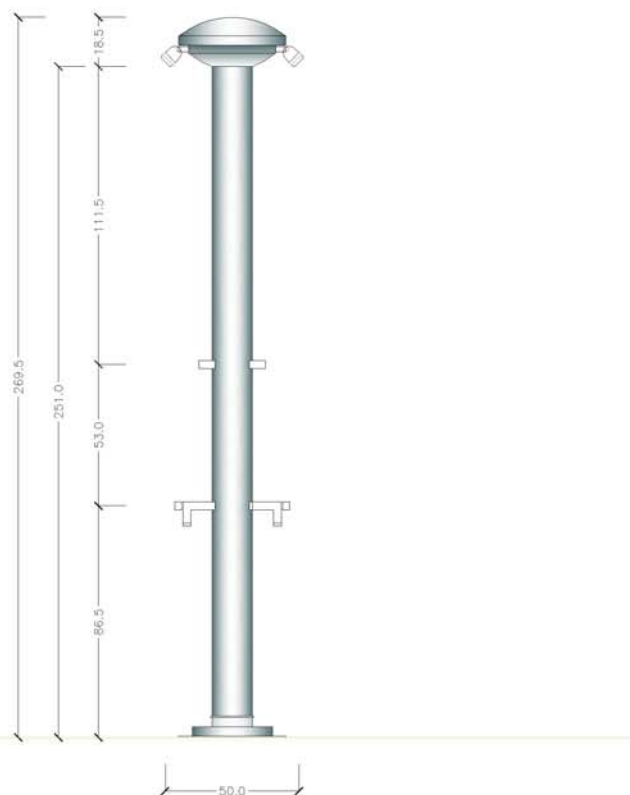

PROSPETTO



PIANTA



SCALA 1:20

## PANCHINA DITTA TEGOLAIA

Elemento costituito da 2 basamenti portanti di forma poliedrica in cls trattato con resine antidegrado. Seduta costituita da 3 liste in legno di Cedro Canadese trattato, bulloneria in acciaio.

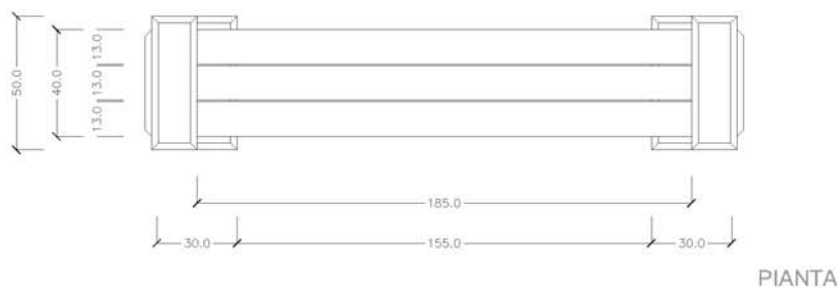

SCALA 1:20



PORTABICI

Elementi per il parcheggio di biciclette in legno naturale o dipinto e tondini in acciaio.

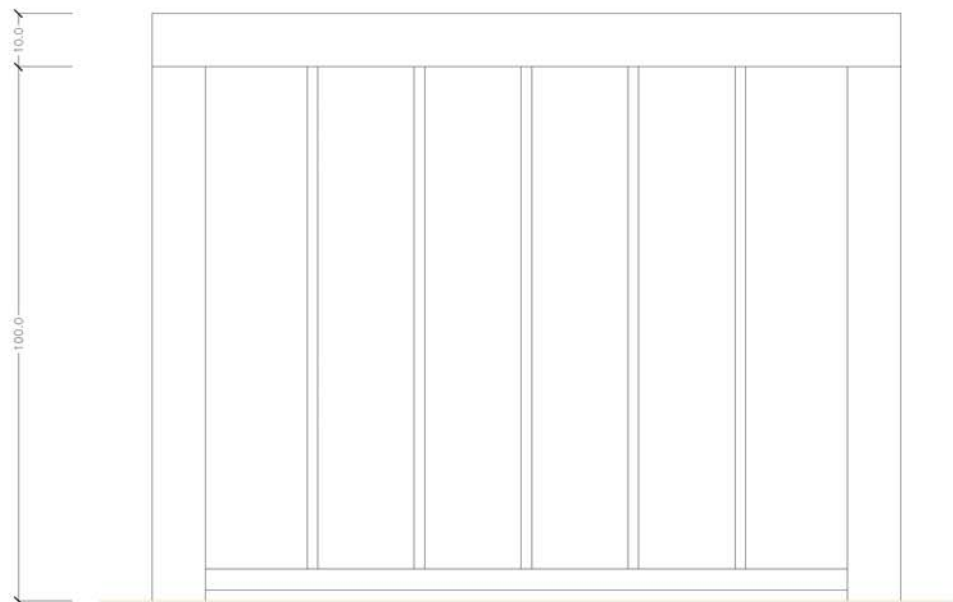

PROSPETTO

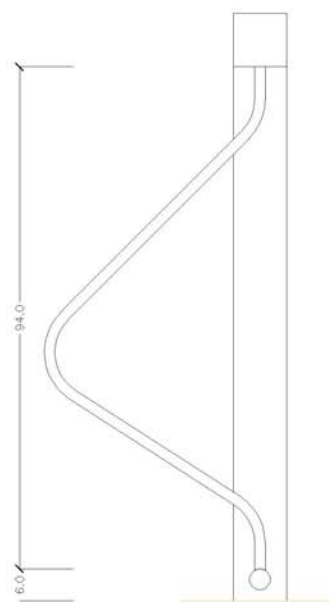

SEZIONE



PIANTA

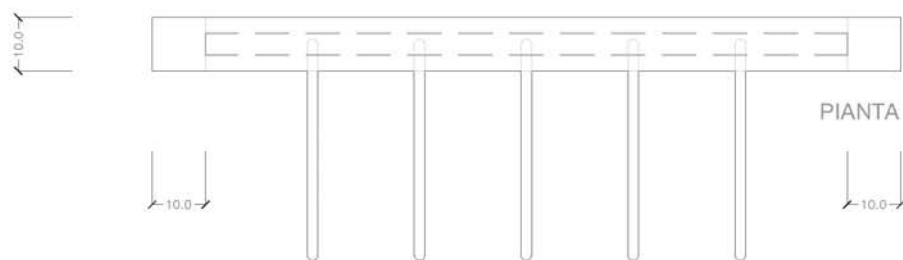

SCALA 1:10

## PORTABICICLETTE

Portabiciclette con struttura portante in cls ed inserisci-ruota in metallo verniciato.

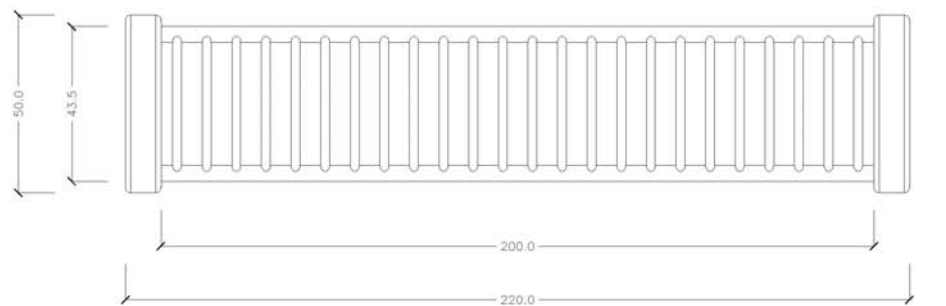

PIANTA



PROSPETTO

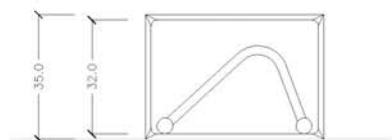

SEZIONE

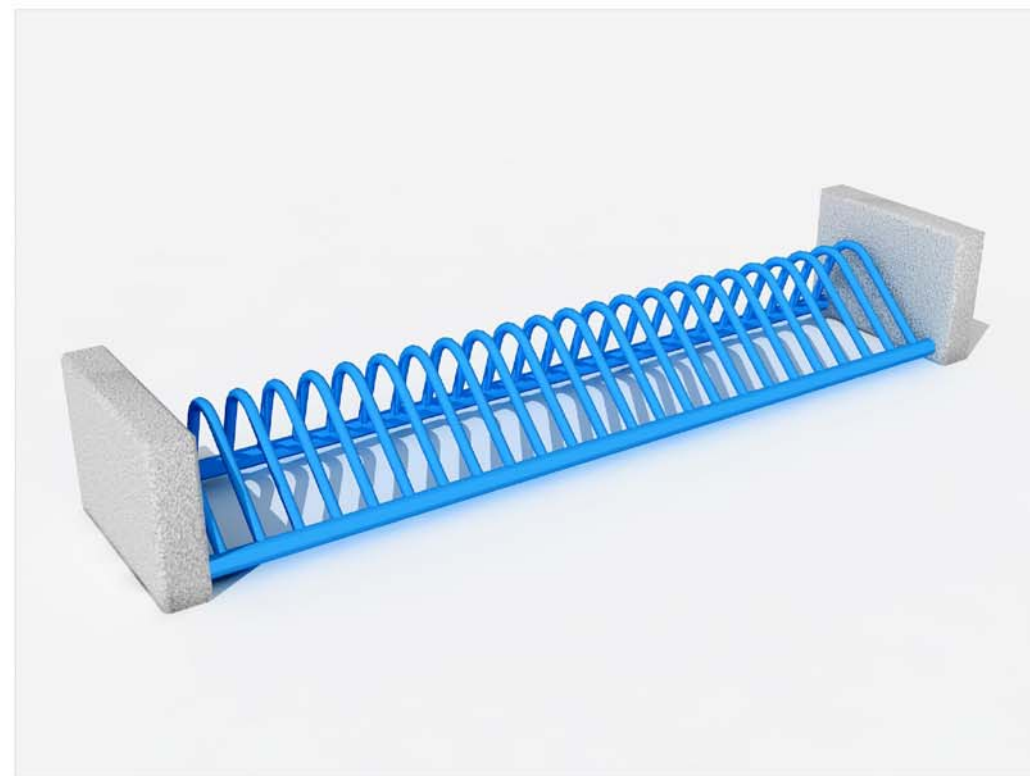

SCALA 1:15



COMUNE DI CAVALLINO-TREPORTI

PROVINCIA DI VENEZIA

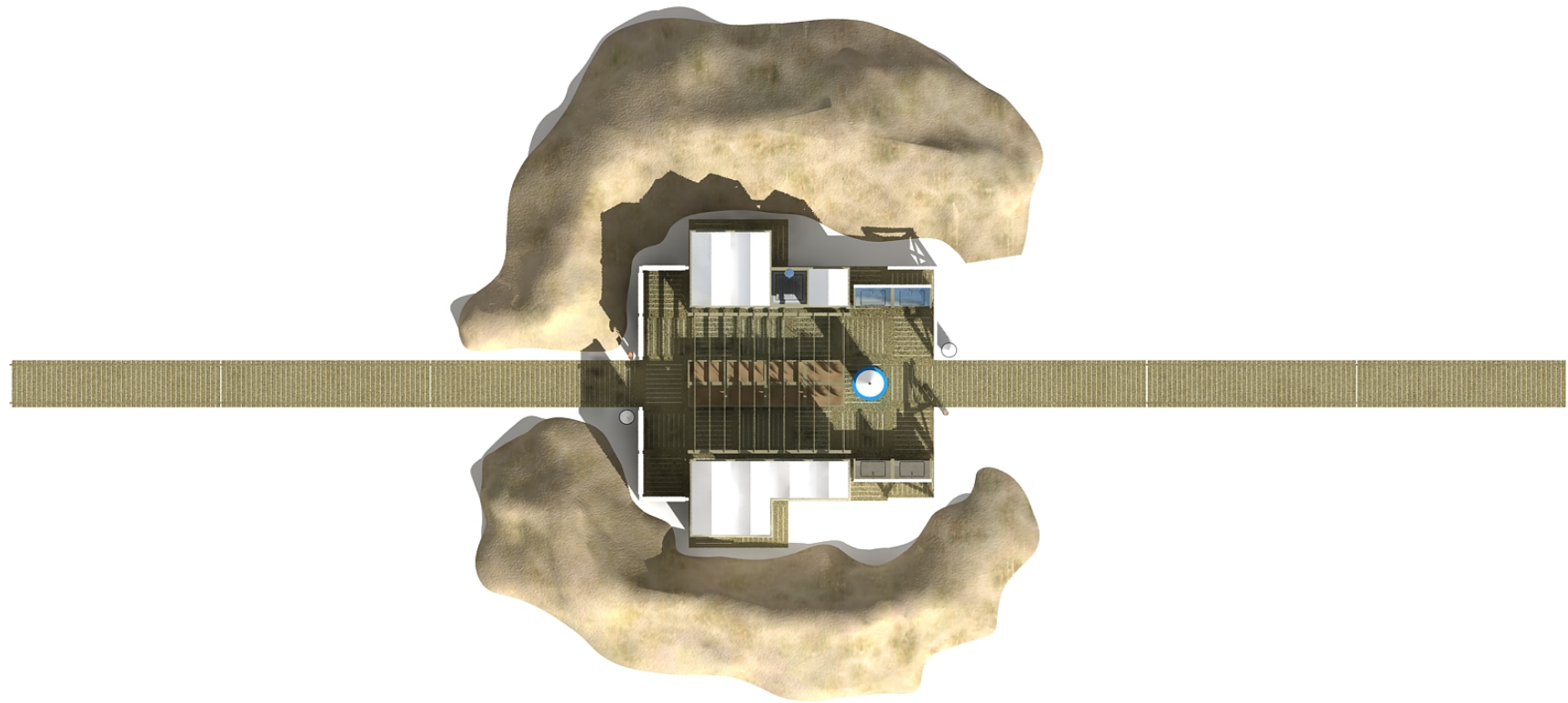

SERVIZI AVVOLTI DALLE DUNE  
VISTA ZENITALE

SCHEMA CAMPIONE

Impianto tipo comprendente:  
n° 3 cabine (1 per disabili)  
n° 3 servizi (1 per disabili)  
n° 2 lavelli  
n° 2 cestini / n° 2 posacenere  
n° 1 totem informazione

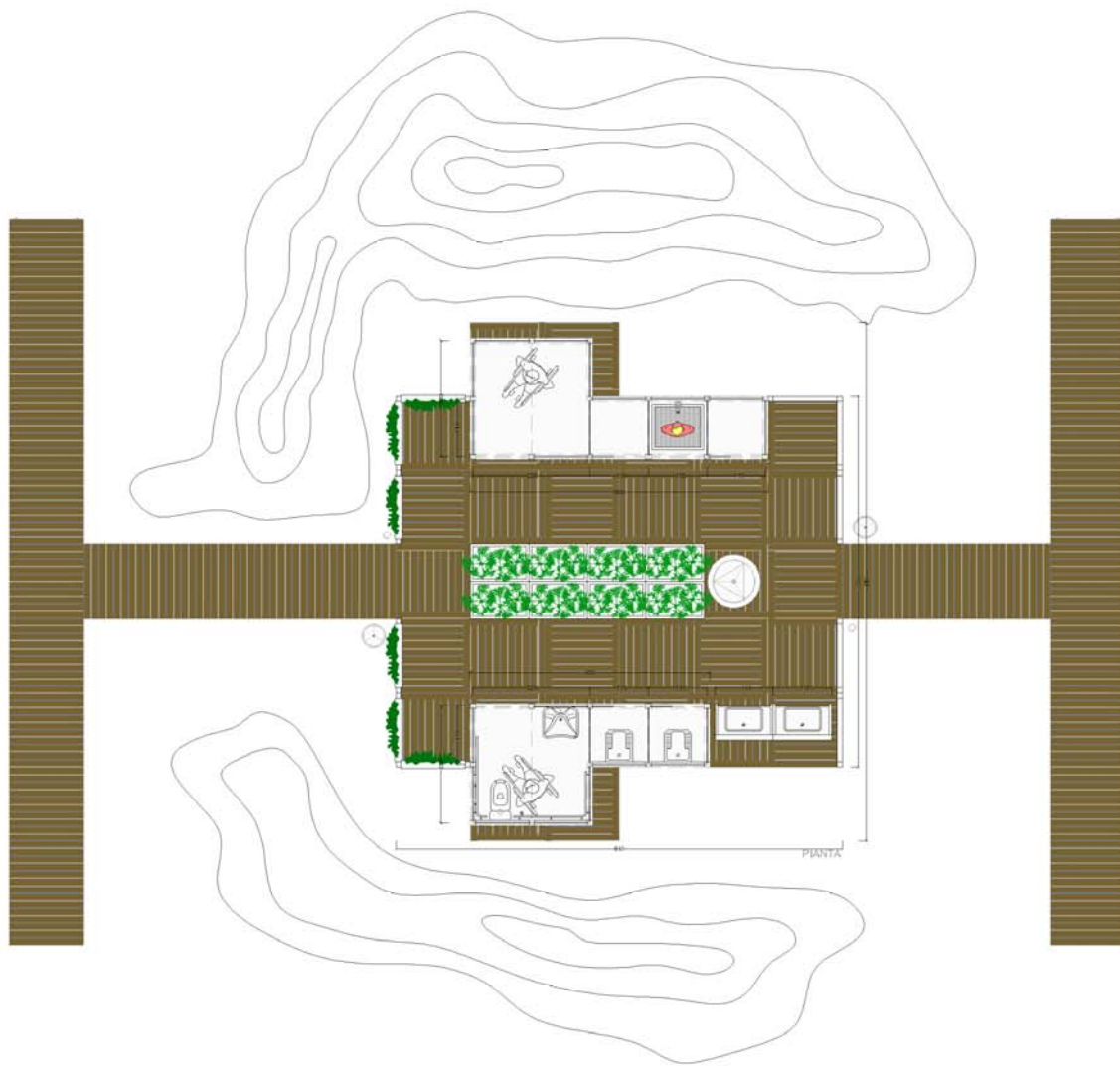

SCALA 1:50

BEZDIKIAN ARCHITECTS

www.bezdikian.com

STABILIMENTO CAMPIONE

LUGLIO 2007

# COMUNE DI CAVALLINO-TREPORTI

PROVINCIA DI VENEZIA

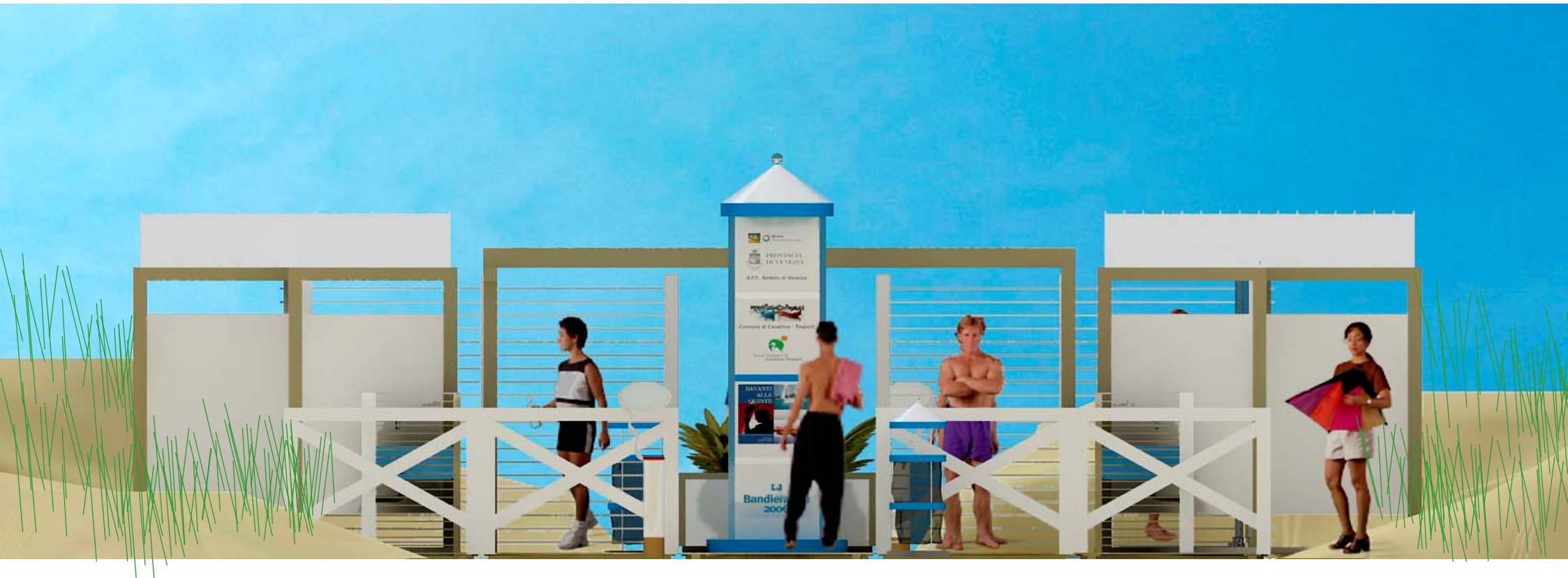

## LO SKYLINE DELLE CABINE



# COMUNE DI CAVALLINO-TREPORTI

PROVINCIA DI VENEZIA



RENDER - 01



# COMUNE DI CAVALLINO-TREPORTI

PROVINCIA DI VENEZIA



RENDER - 02



# COMUNE DI CAVALLINO-TREPORTI

PROVINCIA DI VENEZIA



RENDER - 03

# COMUNE DI CAVALLINO-TREPORTI

PROVINCIA DI VENEZIA



RENDER - 04



# COMUNE DI CAVALLINO-TREPORTI

PROVINCIA DI VENEZIA



RENDER - 05



# COMUNE DI CAVALLINO-TREPORTI

PROVINCIA DI VENEZIA



## COMPOSITING - 01



# COMUNE DI CAVALLINO-TREPORTI

PROVINCIA DI VENEZIA

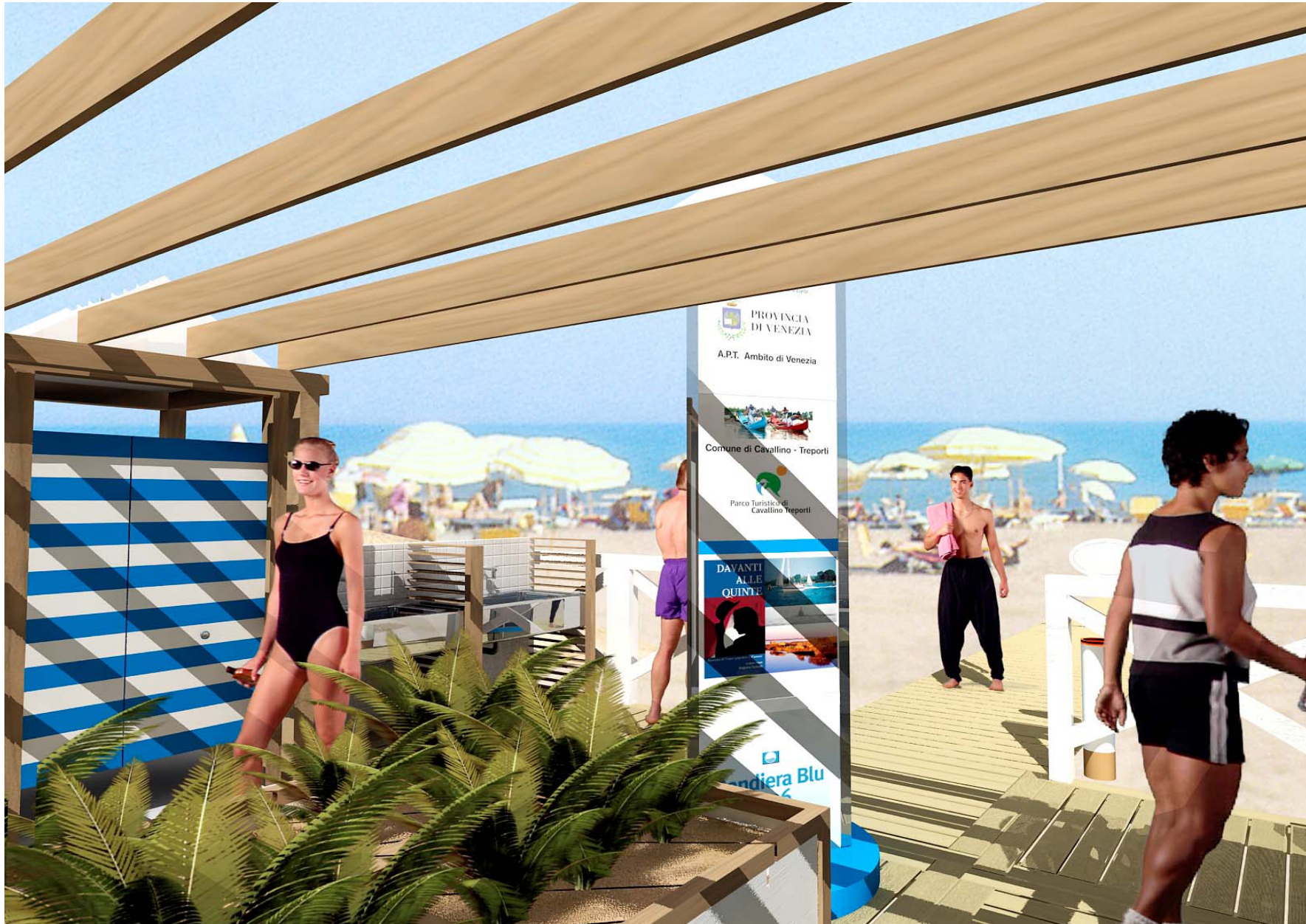

COMPOSITING - 02



# COMUNE DI CAVALLINO-TREPORTI

PROVINCIA DI VENEZIA



## COMPOSITING - 03



# COMUNE DI CAVALLINO-TREPORTI

PROVINCIA DI VENEZIA



COMPOSITING - 04



# COMUNE DI CAVALLINO-TREPORTI

PROVINCIA DI VENEZIA



COMPOSITING - 05